Haier

Refrigerator

SERVICE MANUAL

CAUTION

READ THIS MANUAL CAREFULLY TO
DIAGNOSE TROUBLE CORRECTLY
BEFORE OFFERING SERVICE .



MODEL AFD631

AFL631

CFL633

CFE633

Haier Group

CONTENTS

CONTENTS	1
SAFETY PRECAUTIONS	2
SPECIFICATIONS	4
Specifications	4
Main Functions and Features	7
Explanation of the Models	7
PARTS IDENTIFICATIONS	8
Product Dimensions	8
Three-Door Refrigerator Structure.....	9
Two-Door Refrigerator Structure.....	10
DISASSEMBLY	11
Positioning the Refrigerator	11
Precautions During Dismantling and Installation of the Door	11
Installing the Freezer Drawer Handle	11
Installing and Removing Door	11
Removing the Freezer Drawer	14
Removing the Cabinet Display Panel	15
Removing the Air-Duct	15
CONTROL AND DISPLAY SYSTEM	17
Control Panel and Display Panel	17
Sensor Distribution and Malfunction Codes.....	22
SYSTEM FLOW CHART	24
Refrigeration System Flow Chart	24
Perspective of the Refrigeration System.....	25
Air flow chart	26
CIRCUIT DIAGRAM	27
ELECTRICAL CONTROL PRINCIPLE	28
Overview.....	28
Main Control PCB.....	28
Control Principle of the Air Escaper.....	29
Control Principle of the Fan.....	29
Defrosting Control Principle.....	29
Refrigerator Test Model	29
TROUBLE SHOOTING	30

SAFETY PRECAUTIONS

1. Check if there is any leak of current.
2. Cut out the power supply before the repair to avoid an electrical shock hazard.
3. In the case of a live-line test, insulating gloves should be worn to avoid potential electrical shock.
4. Confirm the rated current, voltage and capacity before testing with any kinds of instruments.
5. Watch if the upper door is open when you check something at a lower position.
6. Take out every part in the cabinet before moving the machine, especially things like panels (e.g. glass shelf).
7. Please wear intact cotton gloves when repair any parts of the evaporator, so that scratches by the sharp fins can be avoided.
8. If there is a breakdown with the refrigeration system, please surrender the machine to the service center, else the leaked refrigerant may pollute the atmosphere.
9. The refrigerator use AC of 220~240V with a frequency of 50Hz.
10. A big fluctuation of voltage (exceed the range 220~240V) may cause a start failure of the refrigerator, a burn-out of the control panel and compressor, or an abnormal sound from the compressor in operation. In this condition an automatic voltage regulator over 750W should be added.
11. Take care not to damage the supply line. Don't yank at the line; pull the plug out gently from the receptacle. Don't press the line under the cabinet or step on it. Take care not to roll on or damage the supply line when moves the machine from the wall.
12. Don't use the supply line any more when there is damage to the line or an abrasion to the plug. Go to the authorized service center for a replacement.
13. In the case of leakage of inflammable gases like carbon monoxide, open the door and windows. Don't pull out or insert the plugs of the appliance.
14. This product is designed only for household use. Any put of medicine, dangerous flammable, explosive articles and highly corrosive acid or base is forbidden.
15. It is recommended not to put any receptacles, stabilized power supply or appliances like microwave oven on the board of the refrigerator. Don't use appliance within the

SAFETY PRECAUTIONS

refrigerator (except recommended type), else there may be electromagnetic interference or other accidents.

16. Don't store or use gasoline and other flammable articles near the refrigerator which may lead to a fire accident.

17. Don't hook on the door, else the door may be slanted or the machine may be tipped over and injure people.

18. Don't place unstable articles on the refrigerator (e.g. weights and containers with water), else the weights may hit people and the leaked water may cause leak of current.

19. Don't touch the refrigeration surface of the freezing compartment when the refrigerator is in operation, especially when your hand is wet, else you may be glued to the surface.

20. Don't spray at the refrigerator, or locate it at a damp place, else the insulation of the refrigerator may be impaired.

21. Any disassembly or alternation to the refrigerator is strictly forbidden. Damage to the refrigeration pipeline is prohibited. Service to the refrigerator must be carried out by professionals.





22. Don't put bottles of beer and other drinks into the refrigerator; else the bottles may be cracked with cold.

23. Pull out the plug of power supply during clearance or power outage. Wait at least five minutes to resume the power supply in order to prevent damage to the compressor caused by continuous restart.

24. Remove the door and the door seal when the refrigerator is out of use, in case that accident may happen to children coming in to play

SPECIFICATIONS

2.1 Specifications

FRIEND 60CM COMBI RANGE			Avantgarde 2	Avantgarde 3	Elegance	Classic
1.	Cluster		Avantgarde 2	Avantgarde 3	Elegance	Classic
	Model		AFD 631 CX AFD 631 CB AFD 631 CS	AFL 631 CB AFL 631 CS	CFL 633 CB CFL 633 CS	CFE 633 CW
	Sketch					
	TBD to be defined, "-" without, " x" with					
	Product description (Refrigerator/Freezer)		Refrigerator	Refrigerator	Refrigerator	Refrigerator
	Type of appliance (FS= freestanding / BI= built-in)		FS	FS	FS	FS
	Type of cooling system(NF=no frost/ S=static)		NF	NF	NF	NF
	Energy efficiency class	08	A+	A+	A / A+	A / A+
		09	A+	A+	A / A+	A / A+
	Climate class*		SN/ST	SN/ST	SN/ST	SN/ST
	Freezer compartment / Star rating		4*	4*	4*	4*
	Approvals (VDE / TÜV / IMQ / NF / ÖVE / DEMKO etc.)		TÜV/GS (Rhl.)	TÜV/GS (Rhl.)	TÜV/GS (Rhl.)	TÜV/GS (Rhl.)
			VDE(After Mar,2008)	VDE(After Mar,2008)	VDE(After Mar,2008)	VDE(After Mar,2008)
	Certifications (CE / ISO 9001/2)		CE / ISO 9001	CE / ISO 9001	CE / ISO 9001	CE / ISO 9001
	Rohs		x	x	x	x
2.	Key features					
	Gross capacity	L	340	340	342	342
	Total net capacity	L	308	308	336/310	336/310
	Net capacity refrigerator compartment	L	230	230	230	230
	Net capacity freezer compartment *ice cube compartment	L	78	78	106/80	106/80
	Freezing capacity	kg	14kg	14kg	14kg	14kg
	Energy consumption / year	kWh	317	317	319	319
	Max storage time at breakdown <i>Freezer</i>	Min	16	16	16	16
	Defrosting (M=manual A=automatic)		A	A	A	A
	Frost free system		x	x	x	x

	Defrost water outlet		x	x	x	x
	Air circulating ventilator		x	x	x	x
	Kind of coolant (R134a/R600a)		R600a/ 55g	R600a/ 55g	R600a/ 52g	R600a/ 52g
	Foaming components (R141b / R134a / C-P)	PU/	C-P	C-P	C-P	C-P
3.	Technical data					
	Voltage / frequency	V/Hz	220-240~/ 50	220-240~/ 50	220-240~/ 50	220-240~/ 50
	Input power / mains fuse minimum	W / A	100/ (DC)	100/ (DC)	100/ (DC)	100/ (DC)
	Temperature range (from>to)	°C				
	Refrigerator		1-8°C	1-8°C	1-8°C	1-8°C
	Chiller / Meat Crisper		-0°C / -	-0°C / -	-0°C / -	- / 3-10°C
	Vegetable Crisper		0-10°C	0-10°C	0-10°C	0-10°C
	Freezer		-16 ~-25°C	-16 ~-25°C	-16 ~-25°C	-16 ~-25°C
	Features: (DIN 8950 resp. 8953)					
	Energy consumption (EN 153) per l 100 net / year	kWh	0.282	0.282	0.260	0.260
	Energy consumption (EN 153) per l 100 net / 24h	kWh	0.87	0.87	0.87	0.87
	Cooling system: K=Compressor / A=Absorbtion		K	K	K	K
	Max noise level	dB(A)	42	42	42	42
4.	Aesthetics					
	W=white G=silver gray B=Obsidian ss=stainless		SS/Obsidian/G	Obsidian/G	Obsidian/G	White
	Cabinet / Door / Top / Frame (w / c)		B/B/B/B / G/G/G/G	B/B/B/B / G/G/G/G	B/B/B/B / G/G/G/G	w/w/w/w
	Fascia panel / Handle (w / c)		B/ss	B/ss	g/g	w/w
	F= flat / R= rounded / S= streamline		R	R	R	R
	Inside colour		w	w	w	w
	Compartments number	n°	3	3	2	2
	Bottle compartment	n°	4	4	4	4
	Hinged (r =right l =left) / reversible		r / X	r / X	r / X	r / X
	Freezing compartent integrated with door		x	x	-	-
	Shelves:					
	Number Fridge / Freezer		3 / -	3 / -	3 / -	3 / -
	Type (gr=grill / g=glass / p=plastic)		g / -	g / -	g / -	g / -
	Colour w=white / b=blue / g=green / t=transpar.		t	t	t	t
	Adjustable (Y=yes / N=not)		x	x	x	x
	Foldable Shelf		x	x	x	-
	Bottle Rack		x	x	x	-
	Drawers:					
	Plastic drawers (fully freezing comp.)	n°.	2	2	2	2
	half freezing comp	n°.	2	2	1	1
	Colour of drawer (w=white/t=transp./g=green)		w/t	w/t	t	t
	Crisper:					
	Chiller / Meat (salad crisper) transparent / white		Chiller (t)	Chiller (t)	Chiller (t)	Chiller (t)
	Vegetable crisper(s) transparent / white		t	t	t	t
5.	Equipment & accessories					
	Control panel:		-	-	-	-

	Interior / exterior		Exterior	Interior	Interior	Interior
	Thermometer interior / exterior		Exterior	Interior	Interior	Interior
	Display type		EXTRA HIGH-LED	LED	LED	-
	Control lamps green / yellow /white		g&y	g&y	g&y	-
	Over temperature alarm LED / acoustic		x	x	x	x
	Adjustable thermostat		x	x	x	x
	Fast freeze switch /-function		x	x	x	x
	Deodorizing		x	x	x	-
	Interior light	W	x	x	x	x
	LED light	n°	Full	Full	Full	Half
	Freeze pack(s)	n°	2	2	3	3
	ice maker Manual/ Automatic		M	M	M	M
	Ice cube tray(s)	n°	1	1	1	1
	Butter holder		x	x	x	x
	Egg trays		2	2	2	2
	Adjustable feet front / rear	n°	2 / -	2 / -	2 / -	2 / -
	Castors front / rear		-/x	-/x	-/x	-/x
	Wall spacer grid /-distance holder		- / -	- / -	- / -	- / -
	Lenght of cable/incl. plug	cm	200	200	200	200
	Condenser Backwall / Integrated		B	B	B	B
6.	Product dimensions					
	Unit dimensions (H / W / D)	cm	188/60/67	188/60/67	188/60/67	188/60/67
	Depth Without handle	cm	67	67	67	67
	Depth with open door	cm	1188	1188	1188	1188
	Door open angle	n°	<135	<135	<135	<135
	Net weight	kg	81	81	76	76
7.	Packing dimensions & loadability					
	Packing dimensions (H / W / D)	cm	194.7/166.4/72.5	194.7/166.4/72.5	194.7/166.4/72.5	194.7/166.4/72.5
	Gross weight	kg	91	91	86	86
	40 ' Container load	pcs	54	54	54	54
	40 ' HC Container load	pcs	72	72	72	72
8.	Recycling symbols					
	Packing materials / Recycling simbols (RS)	RS	RS	RS	RS	RS
	Carton <i>weight in gr</i>		6270	6270	6270	6270
	Polystyrene <i>weight in gr</i>	06	2570	2570	2570	2570
	Polyethylene foil <i>weight in gr</i>	04	210	210	210	210
	Wood <i>weight in kg</i>	-	0.000	0.000	0.000	0.000
9.	Service					
	Users instruction (languages)		D / F / I / GB / E / P / NL	D / F / I / GB / E / P / NL	D / F / I / GB / E / P / NL	D / F / I / GB / E / P / NL

SPECIFICATIONS

2.2 Main Functions and Features

- ◆ Removable automatic icemaker (only in some models).
- ◆ The freezer door has been replaced by two drawers. This can better facilitate food access, featuring both energy saving and convenience (only in some models).
- ◆ Half-shelf structure.
- ◆ Innovative long-efficiency lighting system.
- ◆ Foldaway wine holder.
- ◆ Large crisper with humidity adjustment.
- ◆ Holiday function.
- ◆ Power ON/OFF function is set on the display panel (only in some models).
- ◆ Fridge storage compartment can be set on/off separately.
- ◆ Intelligent alarm function: automatic alarm at over temperature, malfunction, door open.
- ◆ Touch keys (only in some models).
- ◆ Deodorizer (only in some models).
- ◆ Zero degree fresh keeping.

2.3 Explanation of The Models

A	F	TDL	1	32
---	---	-----	---	----

PRODUCT FAMILY	REF. SYSTEM	USER INTERFACE	CLASS	VOLUME
T = Table Top	S = Static	M = Mechanical	8 = A+++	05 = 45-54 lt
O = One Door	V = Vented (Fan)	E = Base/Low-end Electronic	7 = A++	14 = 135-144 lt
D = Double Door	F = Full No-Frost	L = Led inside	6 = A+	21 = 195-204 lt
C = Combi (traditional)		D = LCD Display	5 = A	32 = 315-324 lt
A = Combi with Drawers (Avantgarde line)		T = TV Screen	4 = B	35 = 345-354 lt
S = Side by Side (traditional)			3 = C	36 = 355-364 lt
X = 3 doors SBS			2 = D	...
Z = 4 doors SBS			1 = E	
F = Chest Freezer				
U = Upright Freezer				
W = Wine Cooler				

PARTS IDENTIFICATIONS

3.1 Product Dimensions

Three-Door Refrigerator Dimensions:

Refrigerator height $H=1880\text{mm}$

Refrigerator width $W=595\text{mm}$

Refrigerator depth $D=730\text{mm}$

Cabinet depth $D1=576\text{mm}$

Door depth $D2=78\text{mm}$

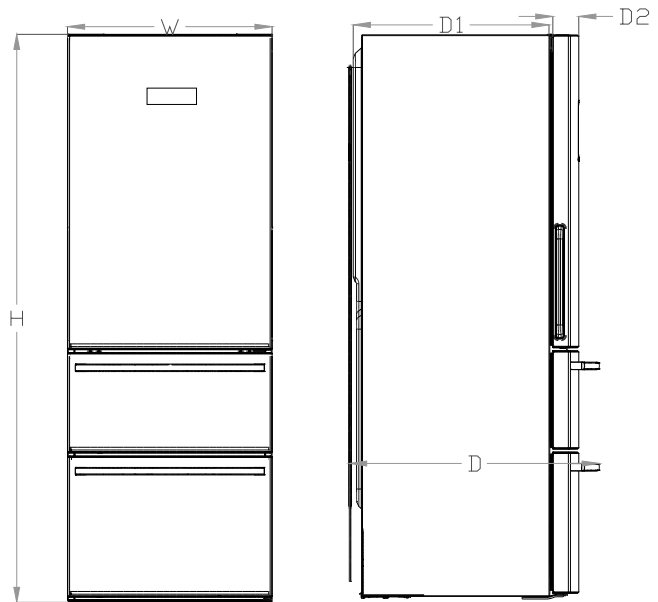

Two-Door Refrigerator Dimensions:

Refrigerator height $H=1880\text{mm}$

Refrigerator width $W=595\text{mm}$

Refrigerator depth $D=670\text{mm}$

Cabinet depth $D1=576\text{mm}$

Door depth $D2=78\text{mm}$

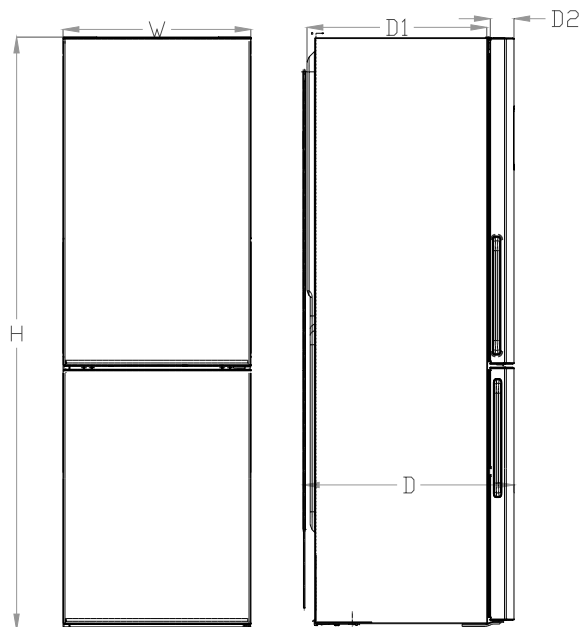

PARTS IDENTIFICATIONS

3.2 Three-Door Refrigerator Structure

Fridge storage compartment

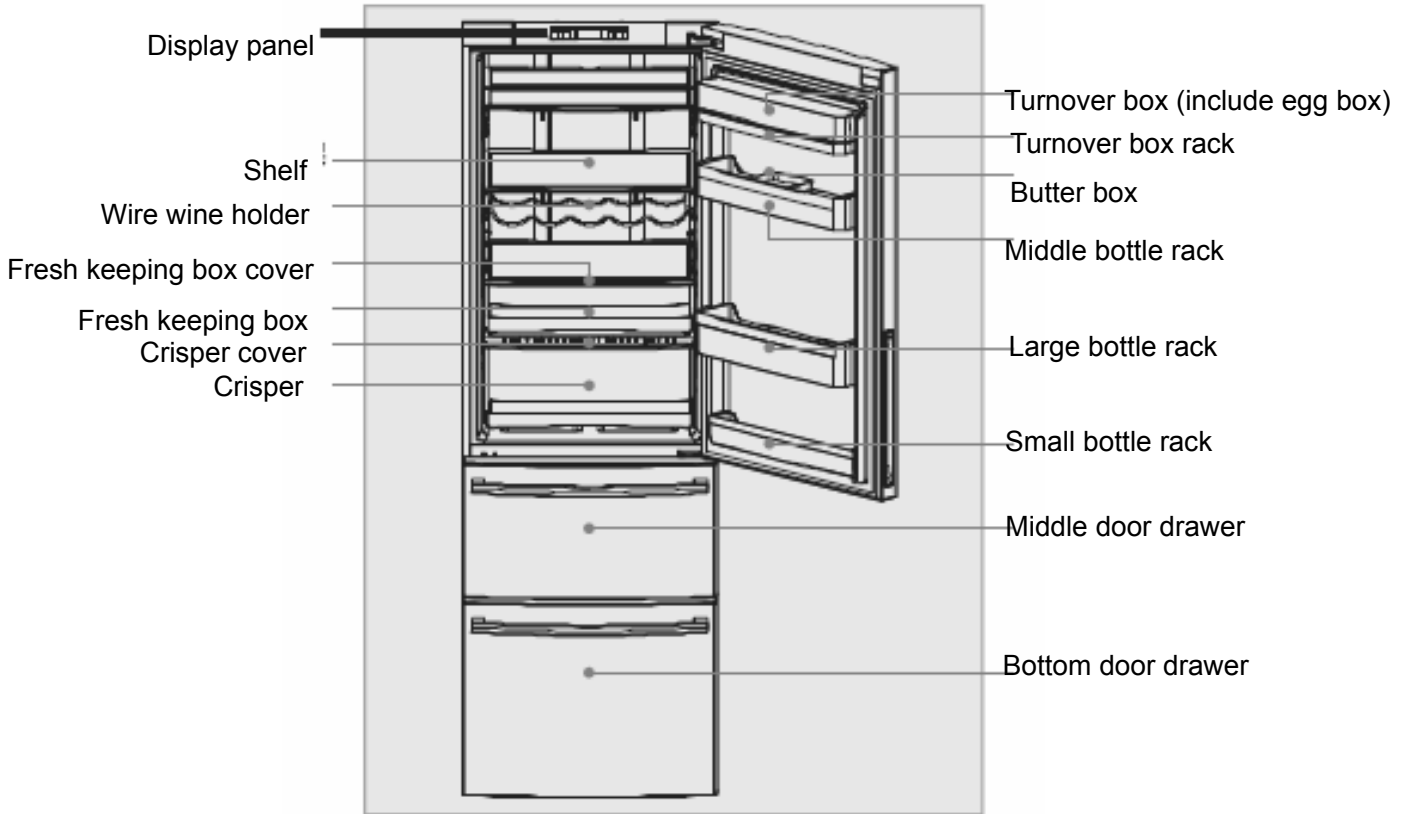

Freezer Drawer Structure

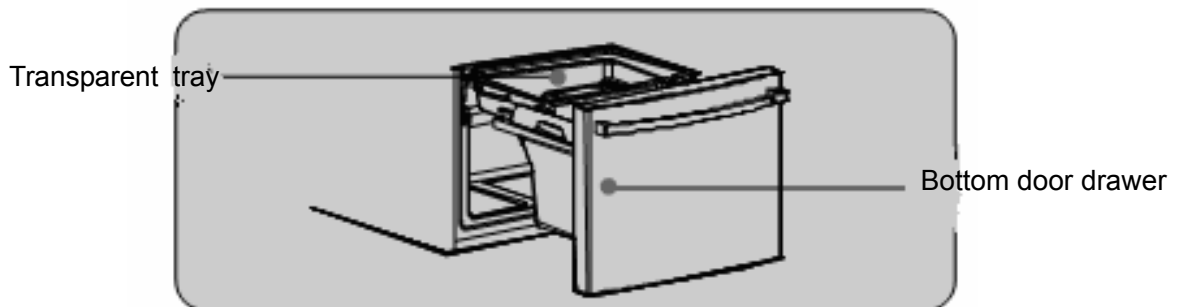
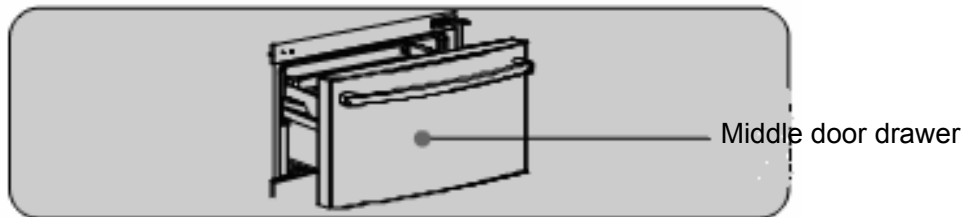

PARTS IDENTIFICATIONS

3.3 Two-Door Refrigerator Structure

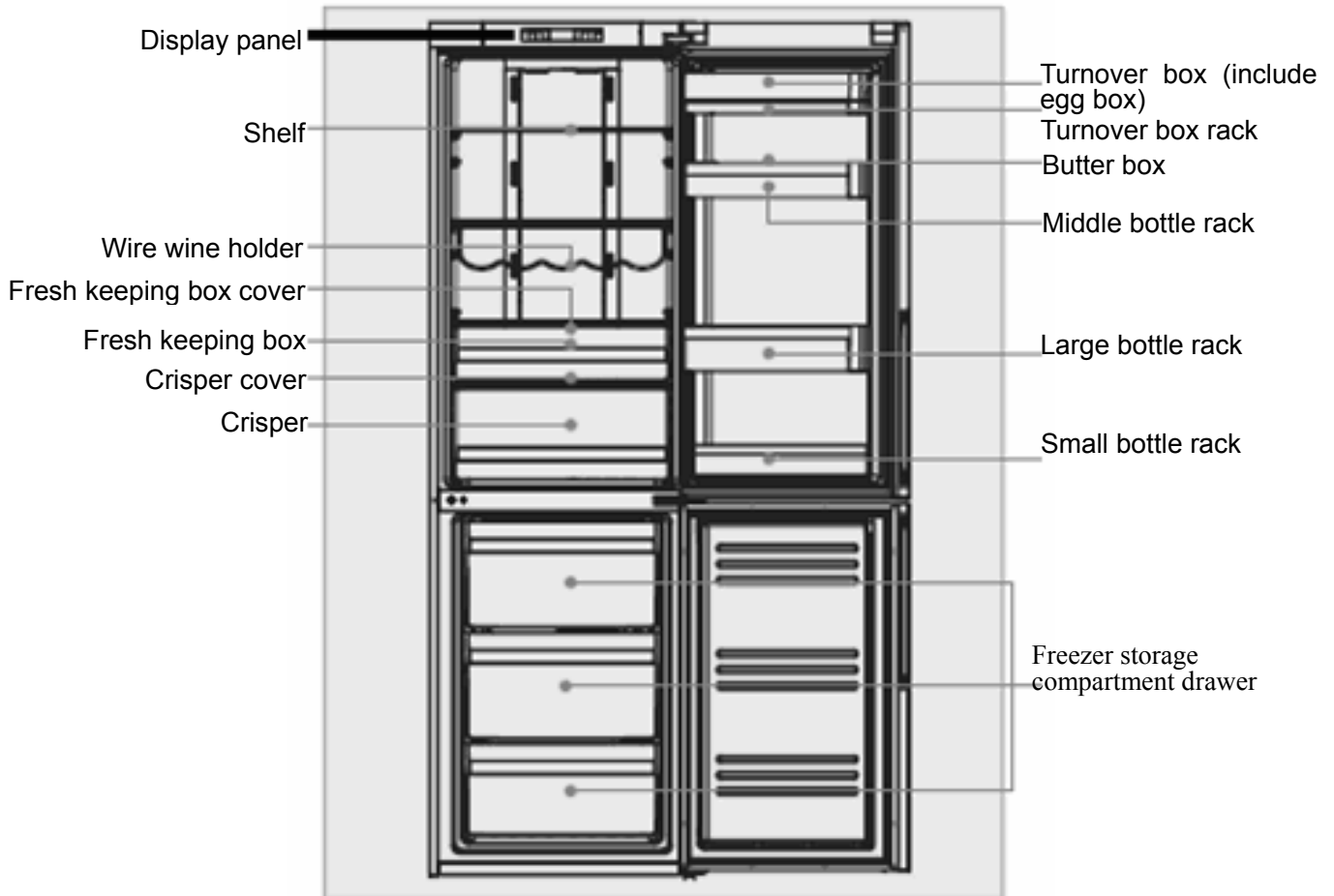

DISASSEMBLY

4.1 Positioning the Refrigerator

The refrigerator should be placed on a flat and solid surface. If the refrigerator is placed on a plinth, flat, strong and fire-resistant material must be used. Never use the foam plinth for packaging. If the refrigerator is slightly unstable, you can adjust the black adjustable feet at the front of the refrigerator.

4.2 Precautions During Dismantling and Installation of The Door

- (1) Before removing the doors, please remove food from the shelves and the bottle guards. Then, unplug the refrigerator power cord to avoid personal injury, product damage or property loss.
- (2) During dismantling of the door, in order to avoid possible personal injury, product damage or property loss, at least two adults are needed to perform the following operations.
- (3) While lifting the hinges to separate it from the door, please take care to prevent the door from falling forward.
- (4) Do not allow children or pets to play in the drawers. There is the risk of suffocation if they are locked in.

4.3 Installing the Freezer Drawer Handle



- (1) Take the handle from the packing bag and align it with the handle seat on the door (note: the screw hole on the handle should be facing downward)
- (2) Secure it with the screw from the bottom.

4.4 Installing and Removing Door

PART-1	Before change	After change

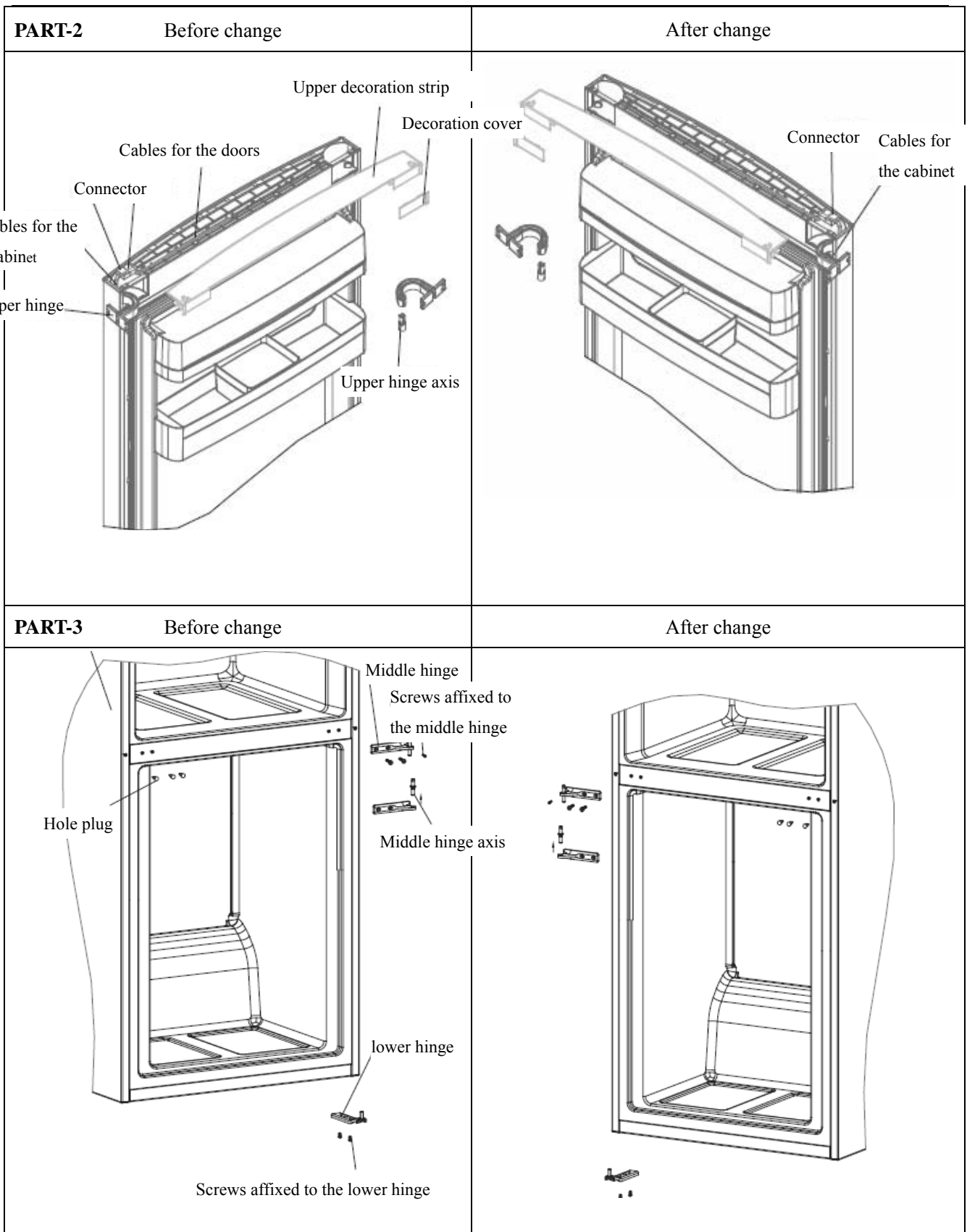

Changing the door opening direction

Part 1: Directions on how to dismantle and install the front decoration strip of the table-board and the upper hinge

- (1) Pull decoration covers 1 and 2 downward to remove them and retain.

DISASSEMBLY

- (2) Detach the 2 screws fixing the front decoration strip of the table-board.
- (3) Lift the front decoration strip of the table-board outward and upward. At this time, there are wires connecting it. Please do not disconnect the wires. Gently put the front decoration strip on the top of the refrigerator.
- (4) Detach the screws affixed to the upper hinge and remove the hinge.
- (5) Turn over the upper hinge and fix it on the other side. Then, install the front decoration strip of the table-board in the reversed direction.
- (6) Secure the 2 screws on the top.
- (7) Install the 2 decoration covers on the front decoration strip of the table-board with their positions exchanged.
- (8) Note: for the models with cabinet display, the front decoration strip of the table-board is different from the one shown in the figure. The dismantling and installation methods are the same.

Part 2: Directions on how to dismantle and install the upper decoration strip and cables

- (1) Remove the decoration covers from the door and retain.
- (2) Remove the upper decoration strip from the door. Insert a “-”screwdriver into the decoration strip at the position shown by the arrow and lightly pull the screwdriver handle in the arrow direction while pulling the decoration strip upward with another hand. In this way the decoration strip will detach away from the door. The operation methods on the right side and the left side are the same.
- (3) Disconnect the connectors and pull out the cables in the door conduit and the cables in the upper hinge conduit respectively.
- (4) Loosen the screws affixed to the upper hinge to remove the hinge. At the same time, the refrigerating compartment door can be lifted up and separated from the middle hinge.
- (5) Pull the axis from the upper hinge. Then, insert it from the other end of the upper hinge. Insert the upper hinge by placing the axis into the door axis hole after turning 180 degrees.
- (6) Remove the stop block on the bottom of the door and then reattach on the other side of the door after turning 180 degrees.
- (7) Turn the middle hinge by 180 degrees and then fit it on the other side of the cabinet.
- (8) Hang the door on the middle hinge and secure the hinge's screws. Connect the two connectors together. Tuck the cables for the door into the conduit on the other side of the door and the cables for the cabinet into the upper hinge conduit.
- (9) Tuck the connected connectors into the conduit on the upper decoration strip and joint the upper decoration strip on the door.
- (10) Turn the decoration piece by 180 degrees and insert it between the door and the upper decoration strip at the other side of the cabinet.
- (11) Note: for the models with cabinet display, the above operation concerning cables is not needed.

Part 3: Directions on how to dismantle and install the middle and lower hinges

- (1) Detach the 3 screws affixed to the middle hinge and remove the hinge. Unscrew the hinge axis and then screw it from the reversed direction.
- (2) Remove the upper and lower doors separately. Dismantle the stop blocks on the bottom of the doors. Turn them by 180 degrees and refit them on the other side.

DISASSEMBLY

- (3) Tilt the refrigerator to the required angle. Detach the screws fixing the lower hinge and remove the hinge.
- (4) Fix the lower hinge to the bottom of the other side of the cabinet. Then, mount the lower door on the lower hinge.
- (5) Take out the 3 hole plugs on the other side of the cabinet.

Turn the middle hinge by 180 degrees and install it on the other side of the cabinet. Attach the 3 screws removed in step 1. Mount the 3 hole plugs into the holes where the hinge is seated originally.

Note: For 3-door refrigerators, the operation concerning the lower hinge is not needed.

4.5 Removing the Freezer Drawer

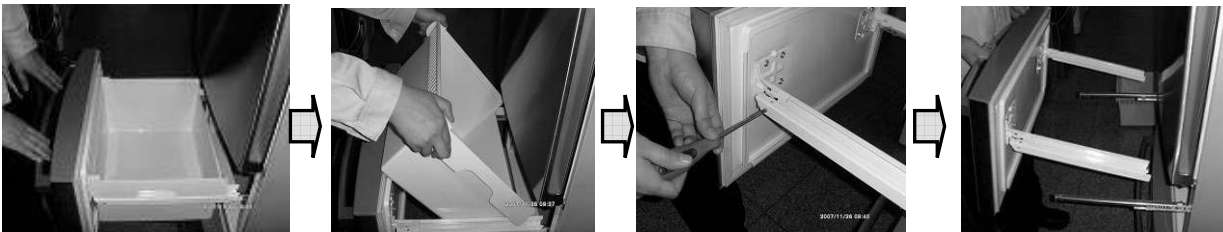

- (1) Open the freezer storage compartment door of the 3-door refrigerator;
- (2) Take out the drawer;
- (3) Detach the screw connecting the rail and the support iron (the screw may be on the inner side of the support iron due to the rail);
- (4) Remove the door.

DISASSEMBLY

4.6 Removing the Cabinet Display Panel

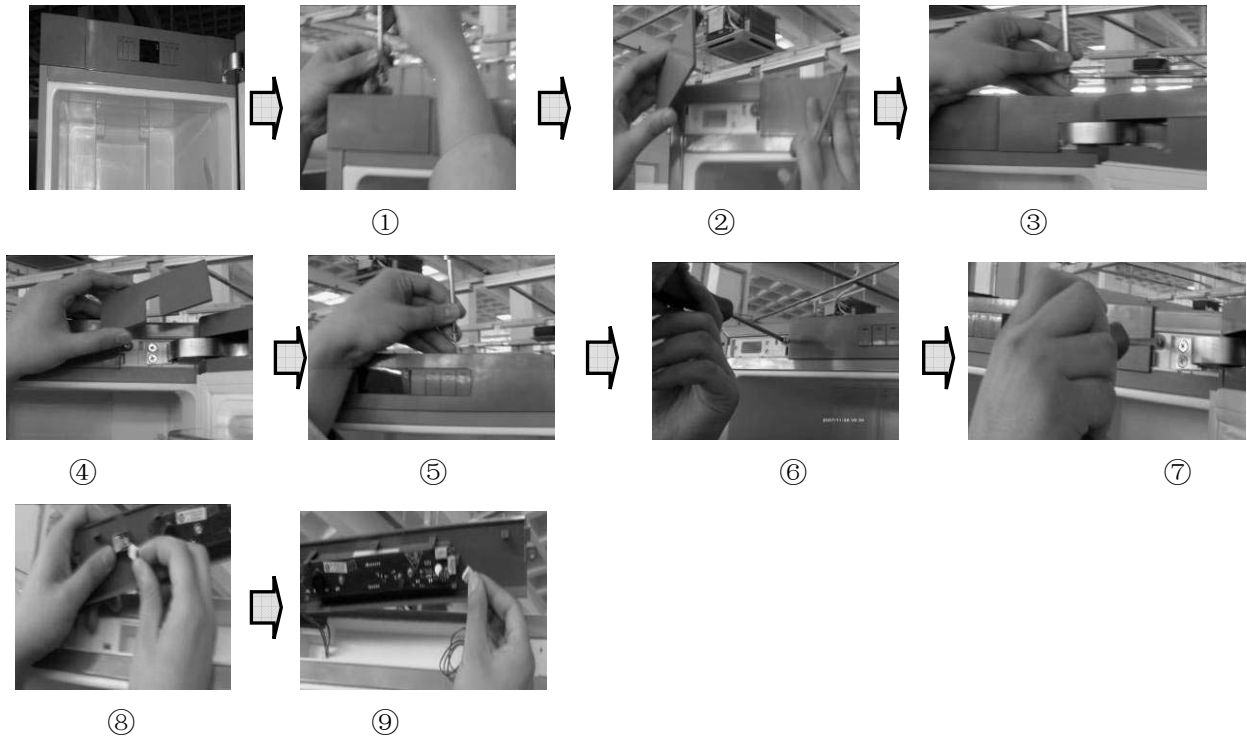

- (1) Detach the screw in the left hinge cover of the cabinet (fig. ①);
- (2) Remove the left hinge cover of the cabinet (fig. ②);
- (3) Detach the screw in the right hinge cover of the cabinet (fig. ③);
- (4) Remove the right hinge cover of the cabinet (fig. ④);
- (5) Detach the 4 screws in the front decoration strip of the cabinet (fig. ⑤⑥⑦);
- (6) Pull out the connector and remove the front decoration strip of the table-board (fig. ⑧⑨).

4.7 Removing the Air-Duct

- Removal of the refrigeration air-duct (unplug the refrigerator before removing the air-duct)

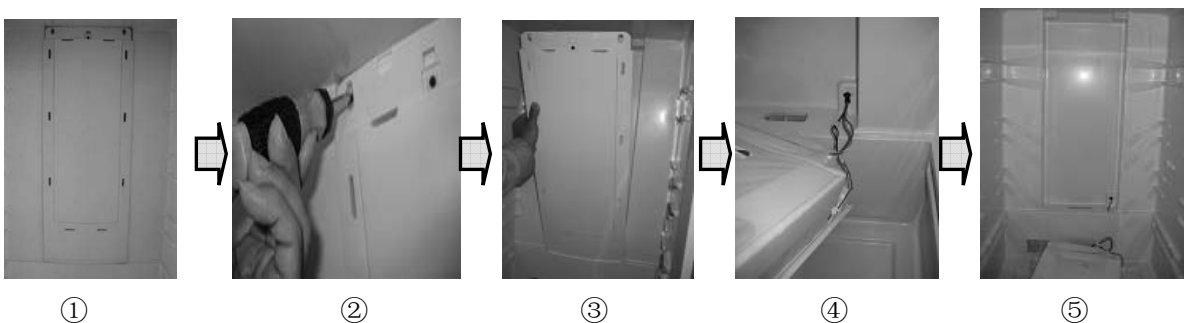

- (1) Take out the accessories in the fridge storage compartment which may interfere with the removal of the air-duct (including shelves, large and small crispers, air-duct decoration strips) (fig. ①);
- (2) Detach the 2 screws in the upper part of the air-duct (fig. ②);
- (3) Tilt the refrigeration air-duct forward entirely around its upper side until you can see the connector on its lower side. Pull out the connector and you can remove the refrigeration air-duct (fig. ③④⑤);

DISASSEMBLY

■ Removal of freezing air-duct (unplug the refrigerator before removing the air-duct)

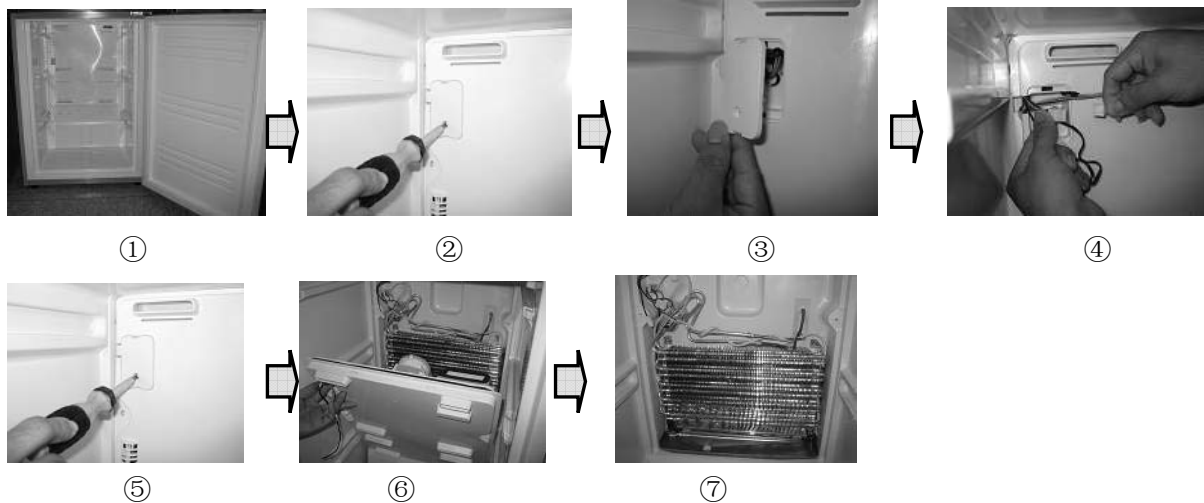

- (1) Take out the accessories in the freezer storage compartment which may interfere with the removal of the freezing air-duct (drawers of 2-door models, middle/bottom doors and drawers of 3-door models) (fig ①);
 - (2) Detach the screw in the harness cover over the freezing air-duct; (fig ②);
 - (3) Remove the harness cover. There is a small indentation on both upper side and bottom side of the harness cover to facilitate the removal (fig ③);
 - (4) Pull out the wires under the harness cover and pull out the connector (fig ④);
 - (5) Detach the 2 screws in the freezing air-duct onto the freezer chamber (fig ⑤);
 - (6) Tilt the freezing air-duct forward from top to bottom and you can remove the air-duct (fig ⑥);
 - (7) Take out the freezing air-duct and the fin evaporator is just behind it (fig ⑦).
- When reinstalling, please connect the connector first and then mount and fix the freezing air-duct.

CONTROL AND DISPLAY SYSTEM

5.1 Control Panel and Display System

5.1.1 Models: CFE633*

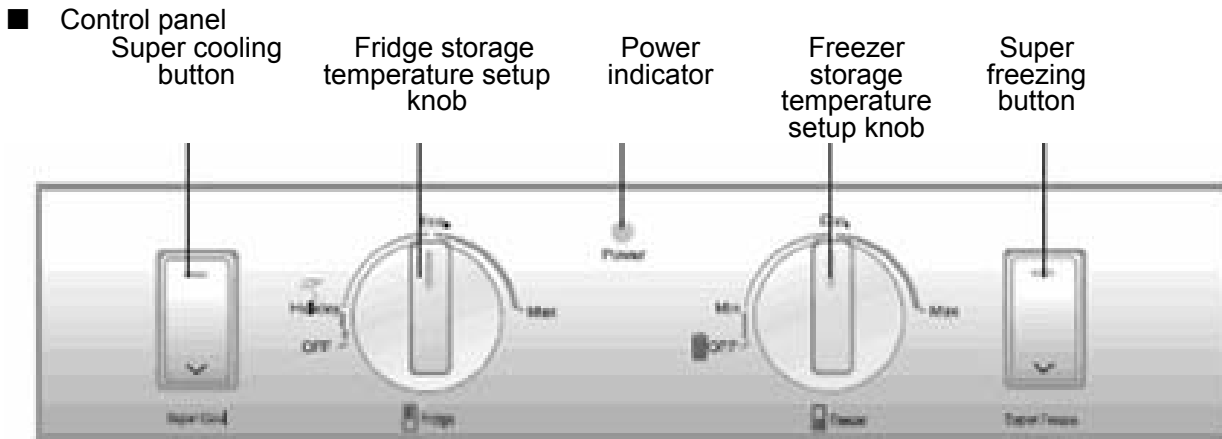

■ Initial powering on

Upon initial powering on, the power indicator will illuminate. There will be alarm due to high temperature in the freezer storage compartment. You can cancel the alarm by pressing any key.

■ Fridge storage temperature setup

The temperature in the fridge storage compartment can be set by turning the fridge storage temperature setup knob. There are three temperature positions for refrigerating: Holiday, Moderate and Super Cool.

■ Freezer storage temperature setup

The temperature in the freezer storage compartment can be set by turning the freezer storage temperature setup knob. There are three temperature positions for freezing: Weak, Moderate and Super Freeze.

■ Super cooling

Select this function after you have put fresh food in the fridge storage compartment. Press the super cooling button, the refrigerator activates this function and corresponding indicator illuminates. This function will automatically deactivate when the temperature decreases to the required level. You can also deactivate it by pressing the super cooling button again.

■ Super freezing

Select this function after you have put large amount of food in the freezer storage compartment. Press the super freezing button, the refrigerator activates this function and corresponding indicator illuminates. This function will become automatically deactivate after 24 hours. You can also deactivate it by pressing the super freezing button again.

■ Holiday function

Turning the fridge storage temperature setup knob to "Holiday" will activate the holiday function of the fridge storage compartment. It will operate at a relatively high temperature. (Please remove any fresh food from the fridge storage compartment and close the door before activating this function)

■ Display control

The display screen will turn off automatically 1 minute after an operation is finished. It will be lit up by opening the door or pressing any key. (Alarm does not light up the display screen)

■ Door open alarming

When the refrigerator door is open for more than 3 minutes, the super cooling indicator will flash and the buzzer will sound 3 beeps every 30 seconds. The buzzer can be silenced by closing the door or

CONTROL AND DISPLAY SYSTEM

pressing any key.

■ Over temperature alarm

When the temperature in the freezer storage compartment rises to a certain value, the Super Freeze indicator will flash and the buzzer will sound 1 beep every second. The buzzer may be silenced when the temperature in the freezer storage compartment drops to a specified level or by pressing any key.

■ Turning off the fridge storage compartment

Set the fridge storage temperature to OFF. The fridge storage compartment will be turned off while the freezer storage compartment operates normally.

■ Turning off the refrigerator

Set the freezer storage temperature to OFF. The refrigerator will stop operating.

This function is not equivalent to turning off the power.

5.1.2 Models: CFL633*/AFL631*

■ Control panel

Fridge storage compartment temperature

Freezer storage compartment temperature

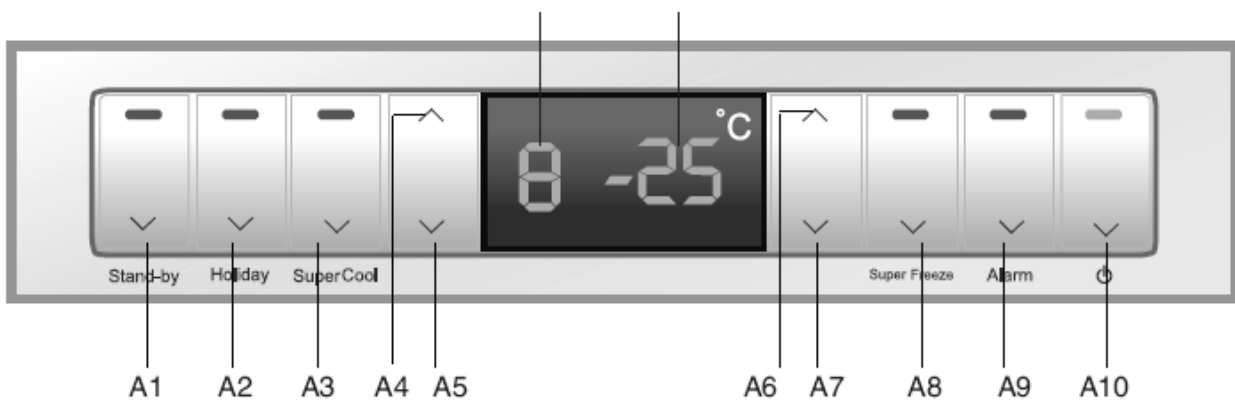

■ Initial powering on

When the refrigerator is powered on for the first time, the power indicator and the fridge storage compartment indicator will light. The fridge storage temperature will be displayed as “-” due to the high temperature inside. The freezer storage temperature will be displayed as“- -” due to high temperature inside. The buzzer will beep. Press key A9, and the buzzer will be silenced. After the temperature decreases to certain level, the displayed temperatures of the fridge storage compartment and the freezer storage compartment will become the ex-factory settings “5” and “-18” respectively.

■ Fridge storage temperature setup

Press key A4 or A5 to set the fridge storage temperature. The fridge storage temperature cycles from 1 to 8. The setting is confirmed automatically 5 seconds after the operation is finished or by pressing any other key.

■ Freezing storage temperature setup

Press key A6 or A7 to set the freezer storage temperature. The freezer storage temperature cycles from -14 to -26°C. It will be confirmed automatically 5 seconds after the operation is finished or by pressing any other key.

■ Super cooling

Select this function after you have put fresh food in the fridge storage compartment. Press key A3, and this function is activated and the corresponding indicator illuminates. This function will automatically

CONTROL AND DISPLAY SYSTEM

deactivate when the temperature decreases to the required level. You can also deactivate it by pressing key A3 again.

■ Super freezing

Select this function after you have put large amount of food in the freezer storage compartment. Press key A8, this function is activated and the corresponding indicator illuminates. This function will become inactive automatically after 24 hours. You can also deactivate it by pressing key A8 again.

■ Holiday function

Press key A2, corresponding indicator illuminates and the holiday function of the fridge storage compartment is activated. It will operate at a relatively high temperature in Holiday mode. The fridge storage temperature will be indicated as “-” (Please take out the fresh food in the refrigerator and close the door before activating this function). Press key A2 again, and the corresponding indicator goes off and the refrigerator comes into normal control.

■ Display control

The display screen will turn off automatically 1 minute after an operation is finished. It can be lit up by opening the door or pressing any key. (Alarm does not light up the display screen)

■ Door open alarming

When the refrigerator door is open for more than 3 minutes, the alarm indicator will flash and the buzzer will sound 3 beeps every 30 seconds. The buzzer can be silenced by closing the door or pressing key A9.

■ Over temperature alarm

When the temperature in the freezer storage compartment rises to a certain value, the alarm indicator will illuminate solid and the buzzer will sound 1 beep every second. The buzzer can be silenced when the temperature in the freezer storage compartment drops to a specified level or key A9 is pressed.

■ Turning off the fridge storage compartment

Press and hold key A1 for 3 seconds, and the corresponding indicator will turn off and the fridge storage compartment will be turned off while the freezer storage compartment operates normally. The fridge storage temperature indication icon will also go off. Press and hold key A1 for 3 seconds again, the corresponding indicator will illuminate, the fridge storage compartment will be turned on, and the fridge storage temperature indication icon will recover.

■ Turning off the refrigerator

Press and hold key A10 for 3 seconds, corresponding indicator will go off, the display panel will go off and the refrigerator will stop operating.

Press and hold key A10 for 3 seconds again, corresponding indicator will light up, the display panel will light up, and the refrigerator will start operating normally.

This function is not equivalent to turning off the power.

■ Fault indication

When E or F is displayed due to fault, the refrigerator can still refrigerate. Please contact professional after-sales service personnel as soon as possible.

5.1.3 Model: AFD631*

■ Control panel

CONTROL AND DISPLAY SYSTEM

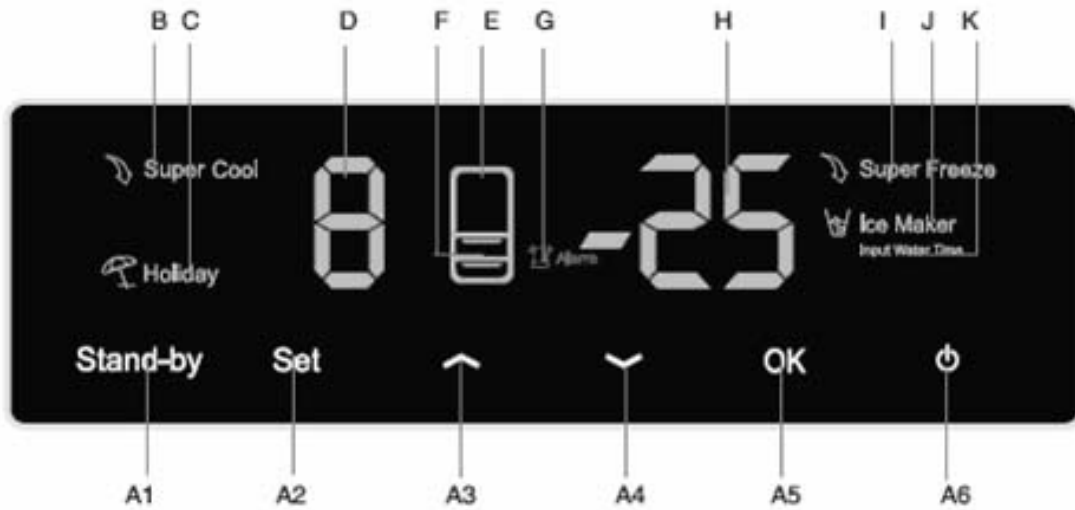

A1 Switch on/off the fridge storage compartment	E Fridge compartment indicating icon
A2 Menu key	F Freezer compartment indicating icon
A3 Temperature up	G Alarm icon
A4 Temperature down	H Freezer storage temperature display
A5 Confirmation key	I Supper freezing icon
A6 Power ON/OFF	J Icemaker icon (only on models with an icemaker)
B Supper cooling icon	K Water injection time adjustment icon (only on models with an icemaker)
C Holiday function icon	
D Fridge storage temperature display	

■ Initial powering on

When the refrigerator is powered on for the first time, icon G will light. The fridge storage temperature will be displayed as “-” due to high temperature inside. The freezer storage temperature will be displayed as“- -” due to high temperature. The buzzer will beep. Press key A5, the buzzer will be silenced and icon G will remain lit. After the temperature decreases to certain level, icon G will turn off and the displayed temperatures of the fridge storage compartment and the freezer storage compartment will become the ex-factory settings “5” and “-18” respectively. The brightness of *** icon will decrease to half automatically when the refrigerator is not being operated.

■ Fridge storage temperature setup

Press key A2 until icon D flashes. Then, press key A3 or A4 to set the temperature. The refrigerating storage temperature cycles from 2 to 8. After you have set it to the desired value, press key A5 to confirm.

Note: Flashing of icon D is accompanied by flashing of icon E

■ Freezer storage temperature setup

Press key A2 until icon H flashes. Then, press key A3 or A4 to set the temperature. The freezing storage temperature cycles from -14 to -24. After you've set it to the desired value, press key A5 to confirm.

Note: Flashing of icon H is accompanied by flashing of icon F

CONTROL AND DISPLAY SYSTEM

- Super cooling
- Press key A2 until icon B flashes. Then, press key A5 to confirm the super cooling function. Icon B will illuminate solid. You can deactivate the super cooling function with the same operation.
- Holiday function
- Press key A2 until icon C flashes. Then, press key A5 to confirm the holiday function. Icon C will illuminate solid. You can deactivate the holiday function with the same operation.
- Super freezing
- Press key A2 until icon I flashes. Then, press key A5 to confirm the super freezing function. Icon I will illuminate solid. You can deactivate the super freezing function with the same operation.
- Ice making function (only on models with an icemaker)
- Press key A2 until icon J flashes. Then, press key A5 to confirm the ice making function. Icon J will illuminate solid. You can deactivate the ice making function with the same operation.
- Icemaker's water injection time adjustment (only on models with an icemaker)
- Press key A2 until icon K flashes. Then, press key A5 to confirm the icemaker's water injection time adjustment. Icon K will illuminate solid. The water injection time will be indicated with icon H and icon D. For example, if the time is 4.0s, icon H will be 4 and D will be 0. Press key A3 or A4 to set the time in an increment of 0.5s. It cycles from 2s to 7s. After you have set it to the desired value, press key A5 to confirm. Icon K will go off. You can exit the icemaker's water injection time adjustment with the same operation.
- Note: this operation can be performed only when the ice making function is selected.
- Display control
- The display screen will dim 1 minute after an operation is finished. It will recover to normal brightness when you open the door or press any key. (Alarm does not light up the display screen)
- Door open alarming
- When the fridge storage compartment door is open for more than 3 minutes, icon G will flash and the buzzer will give out 3 beeps every 30 seconds. If you close the door, the alarm will be silenced and icon G will go off. You can also silence the buzzer by pressing key A5.
- Over temperature alarming
- When the temperature in the freezer storage compartment rises to a certain value, icon G will illuminate solid and the buzzer will sound 1 beep every second. When the temperature in the freezer storage compartment drops to a specified level, the alarm will silence and icon G will go off. You can also silence the buzzer by pressing key A5.
- Switching off the fridge storage compartment
- Press and hold key A1 for 3 seconds, the fridge storage compartment will be turned off while the freezer storage compartment is operating normally. At this time, icon D will go off and icon E will become dim.
- Press and hold key A1 for 3 seconds again, the fridge storage compartment will be turned on, icon D will recover, and icon E will recover its normal brightness.
- Note: if super cooling or holiday function is selected previously, the function will be deactivated and corresponding icon will turn off when the fridge storage compartment is turned off
- Switching off the refrigerator
- Press and hold key A6 for 3 seconds, the display panel will go off and the refrigerator will stop operating. Press and hold key A6 for 3 seconds again, the display panel will light up and the

CONTROL AND DISPLAY SYSTEM

refrigerator will start operating normally. This function is not equivalent to turning off the power.

- Error indication
- When E or F is displayed due to fault, the refrigerator can still refrigerate. Please contact professional after sales service personnel as soon as possible.

5.2 Sensor Distribution and Malfunction Codes

5.2.1 Sensor location description

Malfunction description	Sign	Display	Display position	Sensor location
Malfunction of the ambient temperature sensor	H SNR	F2	Display panel	The ambient temperature sensor is located on the display panel
Malfunction of the fridge storage temperature sensor	R SNR	F3	Display panel	The fridge storage temperature sensor is located on the right side of the fridge storage compartment
Malfunction of the freezer storage temperature sensor	F SNR	F4	Display panel	The freezer storage temperature sensor is located on the left side of the freezing air-duct cover
Malfunction of the defrosting temperature sensor	D SNR	F6	Display panel	The defrosting temperature sensor is located on the fin evaporator
Malfunction of communication between the display panel and the power board	/	E0	Display panel	/
Malfunction of the fan	/	E1	Display panel	/

5.2.2 Graphic display of the sensor location

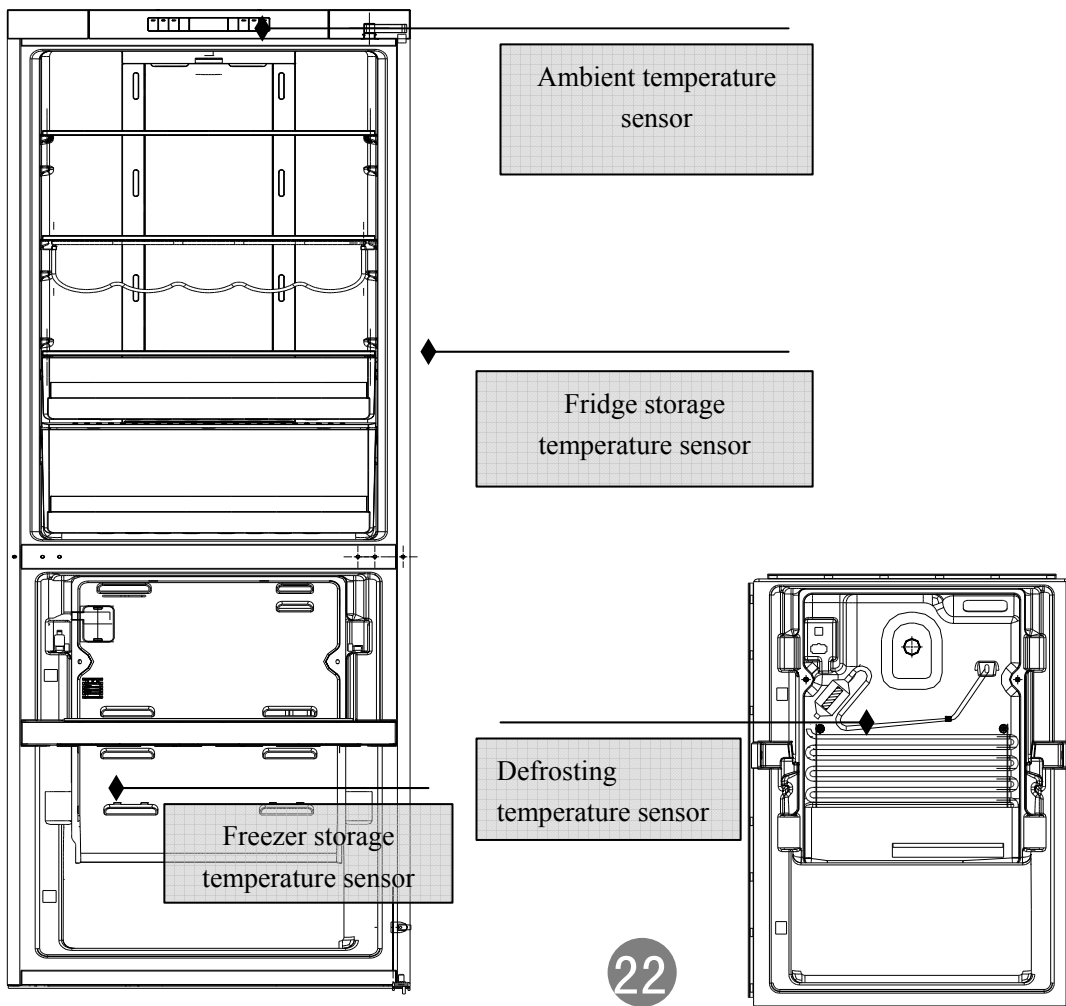

CONTROL AND DISPLAY SYSTEM

5.2.3 Malfunction display

Malfunction display and meaning

NO	Items	Malfunction display	Meaning
1	Normal	Display the temperature setting	No
2	Freezer storage temperature sensor malfunction	F2	F SNR short- or open-circuit
3	Ambient temperature sensor malfunction	F3	RT SNR short- or open-circuit
4	Fridge storage temperature sensor malfunction	F1	R1 SNR short- or open-circuit
5	Defrosting temperature sensor malfunction	F5	D SNR short- or open-circuit
6	Freezer fan malfunction	E1	No signal for more than 30s
7	Communication malfunction	E0	No communication between the display panel and the power board for 2 minutes

SYSTEM FLOW CHART

6.1. Refrigeration System Flow Chart

Refrigeration principle of the refrigerator

1) Principle diagram and description of the refrigeration cycle

The refrigerant is compressed in the compressor, from there, it enters the dry filter, de-dewing tube, and the condenser, and goes into the evaporator after being throttled and decompressed in the capillary tube. Finally, it returns to the compressor through the air return tube.

Principle diagram of the refrigeration cycle

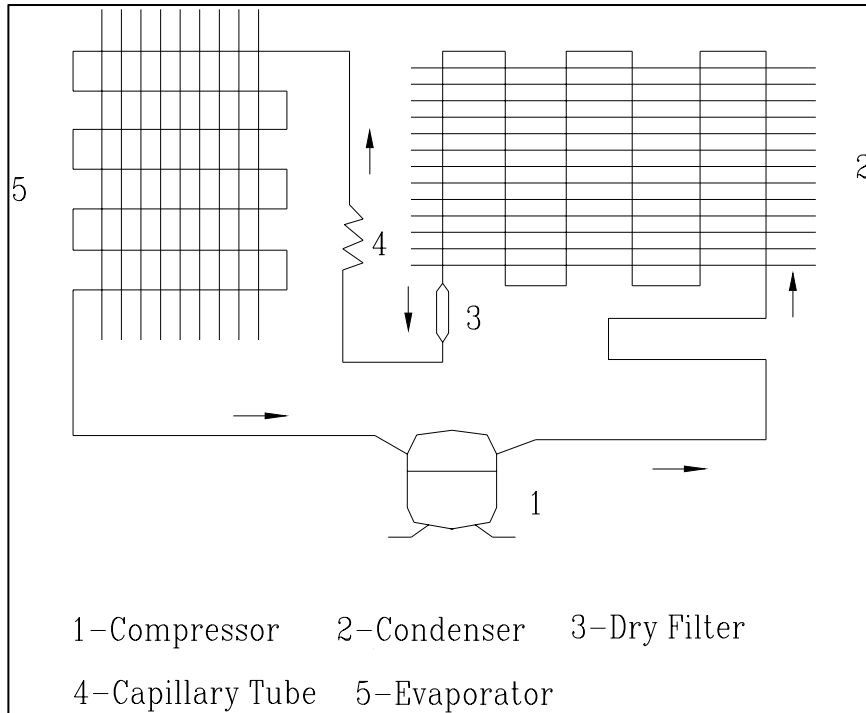

SYSTEM FLOW CHART

6.2. Perspective of the Refrigeration System

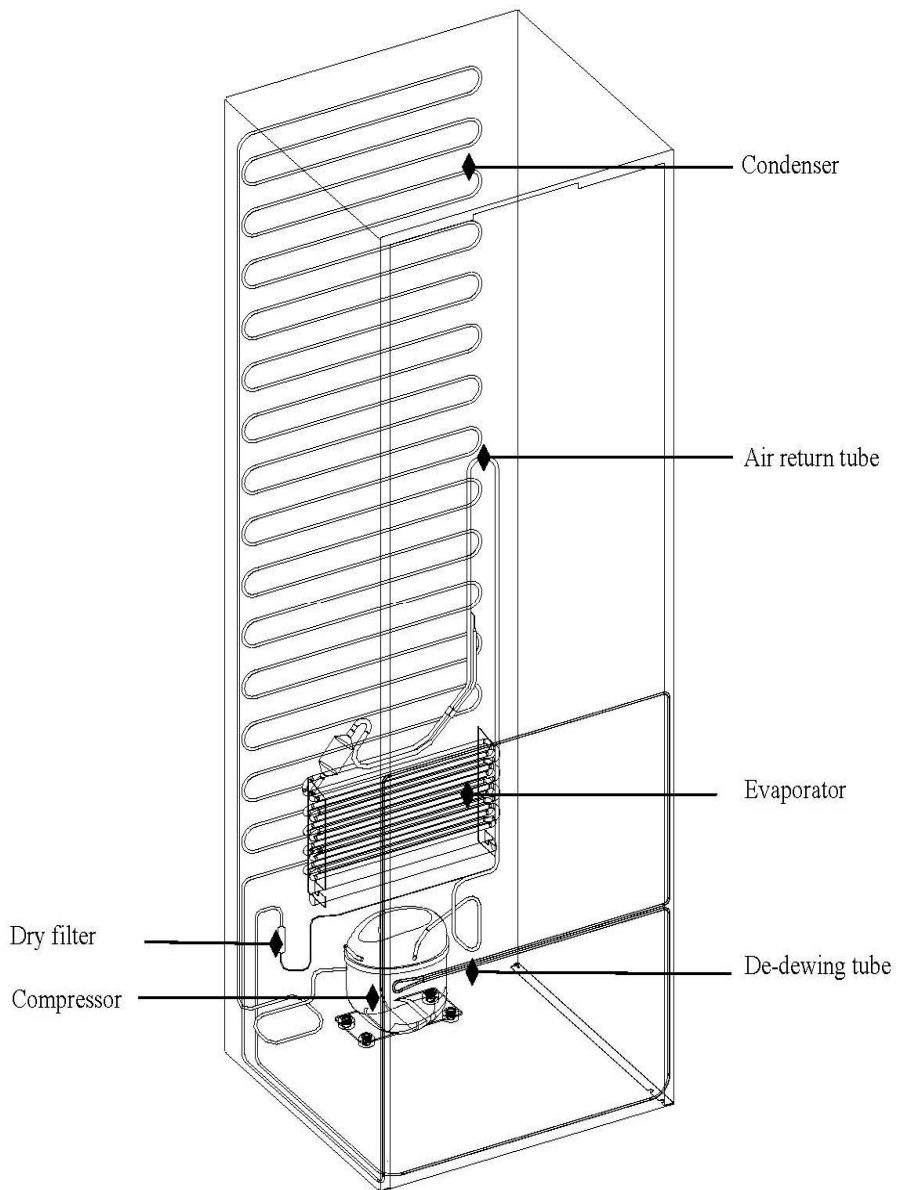

SYSTEM FLOW CHART

6.3 Air Flow Chart

Schematic drawing and description of air circulation in the refrigerator air-duct

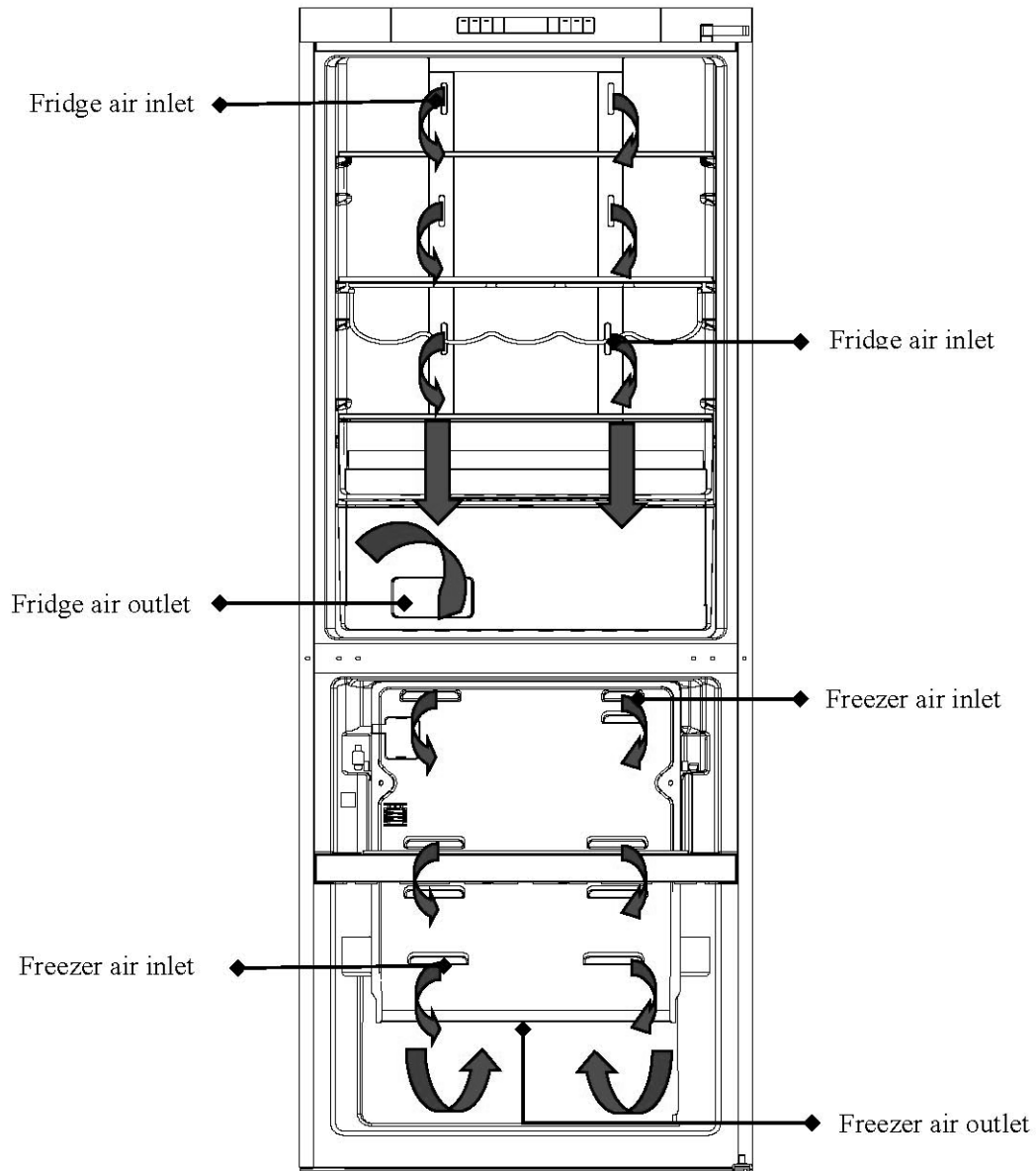

CIRCUIT DIAGRAM

Brief principle diagram

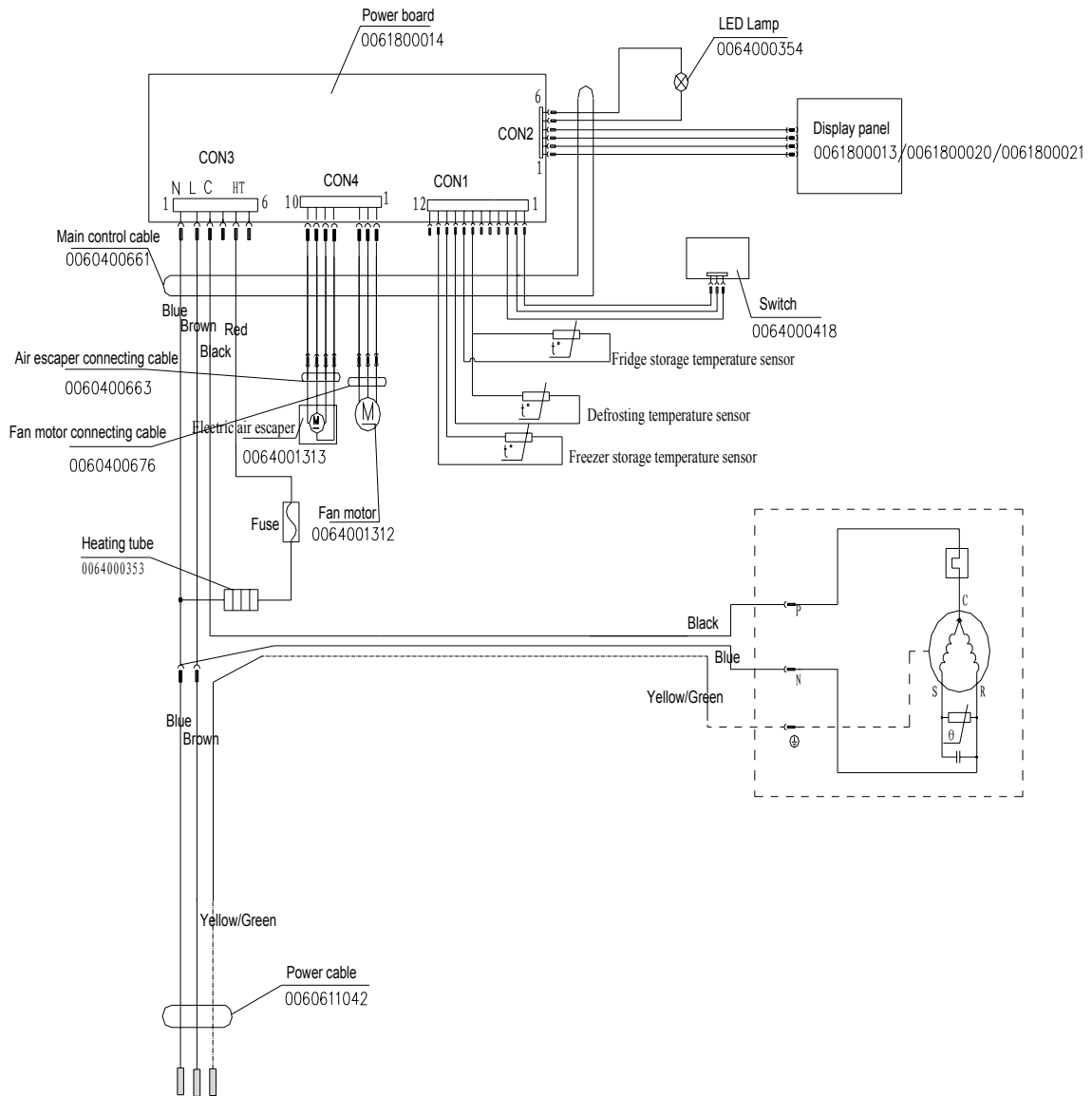

ELECTRICAL CONTROL PRINCIPLE

Electrical control principles of the refrigerator

8.1 Overview

Electrical control principle of CFE/AFL/AFD refrigerators

- (1) Fully air cooling design, controlled with a fixed frequency compressor;
- (2) The temperature in the fridge storage compartment is controlled by controlling the air door with the fridge storage temperature sensor R;
- (3) The temperature in the freezer storage compartment is controlled by controlling the power of the compressor with the freezer storage temperature sensor F;

8.2 Main Control PCB of the Refrigerator

There are 4 connectors on the main control panel of CFE/AFL/AFD refrigerators.

Let's describe these connectors:

CN1 is the connector for the sensors and the door switch. Its pins from the left to right are:

1: GND

2: +12V

3: Door switch signal. When the door is opened, GND and the signal wires are switch to conduction. When the door is open, the wires are disconnected;

4-6: Null

7-8: Connected to the fridge storage temperature sensor. We can test the sensor with these two wires. Its resistance in normal operation is between 6.35 and 3.88k Ω (correspond to 0 $^{\circ}$ C \sim 10 $^{\circ}$ C). The resistance at normal temperature is between 2.45 and 1.58k Ω (correspond to 20 $^{\circ}$ C \sim 30 $^{\circ}$ C);

7-9: Connected to defrosting temperature sensor. We can test the sensor with these two wires. Its resistance in normal operation is between 10.9 and 25.19k Ω (correspond to -10 $^{\circ}$ C \sim -25 $^{\circ}$ C). The resistance at normal temperature is between 2.49 and 1.61k Ω (correspond to 20 $^{\circ}$ C \sim 30 $^{\circ}$ C);

10-11: Connected to the freezer storage temperature sensor. Resistance test is the same as the defrosting temperature sensor;

12: Null

CN2 is the connector for the LED lamps and display panel:

1: GND

2: +5V

3: Com

4: Com

5-6: Null

7: +12V

8: GND

CN3 is the connector for the power cables

1: Zero line

2: Live line

3: Compressor (between it and the zero line)

4: Null

5: Heating tube for defrosting. The resistance between it and the zero is 345 Ω \pm 10%

6: Null

CN4 is the connector for the air door and fan:

1: Feedback signal from the fan

2: GND of the fan

3: +12V of the fan

4: fan +12V

5-6: Null

7-9: Motor of the refrigeration air door

ELECTRICAL CONTROL PRINCIPLE

8.3 Control Principle of the Air Escaper

- (1) The refrigeration air door is controlled with the fridge storage temperature sensor R SNR.
- (2) The air door is closed from the beginning of defrosting until 15 minutes after the defrosting is finished.
- (3) Upon initial powering on or resetting of the control panel, the air door conducts a close-and-open cycle before acting according to the control conditions in item (1).
- (4) The air door will be forced to conduct an open-and-close cycle if it has been closed for 1 hour. After that, its closing/opening will be controlled by R SNR.
- (5) If the temperature is still rising (or dropping) within 10 minutes after opening (or closing) of the air door, it will open (or close) once again.

8.4 Control Principle of the Fan

The freezer fan is controlled by the control panel according to the following conditions. The DC fan's rotation speed is regulated with PWM mode and the AC fan operates directly.

- (1) ON/OFF condition of the freezer fan (The control mode of the DC fan is listed in the table below. The AC fan runs under condition ON and stops running under condition OFF):
 - (2) When the fridge storage compartment door is opened, the freezer fan will run and the refrigeration air door will open. After 2 minutes, the refrigeration air door will close;
 - (3) When the freezer storage compartment door is open, the freezer fan will not run;
 - (4) Conditions for judging LOCK of the freezer fan: If the rotation speed of the fan is less than 300RPM or the fan does not run and the state has persisted for over 30 seconds, a freezer fan malfunction will be displayed. Normal display will be recovered after it becomes normal. Otherwise the freezer fan malfunction will persist.

8.5 Defrosting Control Principle

A defrosting cycle will be started once the compressor has operated for 8 hours accumulatively. It will stop defrosting when the defrosting sensor detects a temperature over 10°C

The compressor stops and the refrigeration air door is closed during defrosting.

After initial powering on or resetting of the control panel, it will start the first defrosting cycle after the compressor has operated for 6 hours accumulatively.

It may enter the defrosting state when the defrosting sensor is malfunctiony (short-circuit or open-circuit). In this case, it will exit the defrosting state after 30 minutes.

8.6 Refrigerator Test Mode

TEST1: Press the TEST key on the power board to enter the 〈PULL DOWN MODE〉, the door display panel displays T1 T1 and the refrigerator enters forced refrigeration state: the compressor operates normally, the fan runs at high speed, and the defrosting heating wire is disconnected. This can be used to test the refrigeration performance.

TEST2: Press TEST key again in TEST1 MODE to enter the 〈FORCED DEFROSTING MODE〉. It will act depending on the temperature sensed by the defrosting sensor

When the temperature sensed by the defrosting sensor is over 10°C, the heating wire will exit the 〈FORCED DEFROSTING MODE〉 after 20s' heating

When the temperature sensed by the defrosting sensor is below 10°C, the heating wire will heat continuously until the temperature sensed by the sensor reaches 7°C

In the 〈FORCED DEFROSTING MODE〉, the door display panel displays T2 T2, the refrigerator conducts forced defrosting, the compressor and the fan are turned off, and the defrosting heating wire is turned on. At this moment, you can test the power of the defrosting heating wire and it should be 153±15W.

TROUBLE SHOOTING

Trouble Shooting

Symptom: food in the fridge storage compartment is frozen

Check:

- 1) Verify that the temperature in the fridge storage compartment is too low and the food is frozen there;
- 2) Remove the decoration piece of the refrigeration air-duct. Detach the 2 screws and take out the air door-foam assembly. Press the "Refrigeration OFF" button to see if the air door closes automatically. If the air door closes tightly, continue to next step. If the air door does not close normally, continue to step 6).
- 3) Disconnect the connection wires of the air door and the LED lamps. Take out the air door-foam assembly. Tear the adhesive tape wrapped around the foam and separate the foam. Check if the seal between the air door and the foam is tight.
- 4) If the seal is tight, check if the fridge storage temperature sensor R1 is OK.
- 5) If the sensor R1 is OK, then the main control panel is probably malfunctioning.
- 6) If the wiring of the air door is OK, check the circuit from the connector of the main control panel to the connector in the cabinet. If there is no problem in this circuit, the air door is malfunctioning.

- Solutions:
- 1) If the seal between the air door and the foam is found to be not tight, please affix seal strip on the interface between the air door and the foam;
 - 2) If the sensor R1 is malfunctioning, please replace it with a new one;
 - 3) If the main control panel is malfunctioning, please replace it with a new one;
 - 4) If the connector of the air door is connected with reverse polarity, please reconnect it correctly;
 - 5) If the air door is malfunctioning, please replace it with a new one.

Symptom: the buzzer beeps to alarm

- 1) Test across pin 1 and pin 3 of CN1 on the main control panel. The 2 pins should be switched to conduction when the door is closed and disconnected when the door is open.
- 2) If pin 1 and pin 3 of CN1 are disconnected in both cases, please remove the front decoration strip to see if the door switch is still in the slot.

Symptom: no defrosting

- Check:
- 1) Activate the forced defrosting function by double pressing the button on the main control panel. Then, check if the temperature of the defrosting heating wire is rising.
If the temperature of the heating wire does not change, remove the fan cover plate to check if all the connectors are connected properly and test if there is 220V voltage output across the terminals of the heating wire.
 - 2) Measure the resistance of the heating wire with a multimeter. It should be around 345Ω.
 - 3) Measure the resistance of the defrosting fuse. If it is zero, the fuse is OK. If it is infinite, the fuse is malfunctioning.
 - 4) If no malfunction is found in the above checks, please test the defrosting temperature sensor with a multimeter.

Symptom: neither displaying nor starting when powering on

- Check:
- 1) Check if the power supply is connected properly.
 - 2) Remove the main control panel and examine its back side carefully to see if there are solder skips or open soldering;
 - 3) Check if the connector of the freezer door hinge is connected properly.
 - 4) Verify the display panel to see if the refrigerator is in OFF state. If so, press and hold the button on the power board for 3s to turn it on.

Solutions:

- 1) If there is dry soldering or open soldering on the control panel, resolder it with an electrical iron.

TROUBLE SHOOTING

- 2) If any connector is not connected properly, replug it firmly.
- 3) Press and hold the button on the power board for 3s to turn the refrigerator on.

Symptom: poor freezing effect accompanied by loud noise

- Check:
- 1) Check if there is apparent abnormal sound in the freezer storage compartment. Remove the fan cover plate, close the refrigeration air door (and the icemaker air door), and check if the freezer fan is operating normally. (The fan does not operate when the refrigeration air door is open. Please first eliminate the possibility of improper installation of the door on-off)
 - 2) If the freezer fan does not run, remove it and check if its connector and the cabinet connector are connected properly. Test if there is approximately 12VDC voltage across pin2 and pin 3 of CN4. If there is no 12VDC voltage, the main control panel can generally be determined to be malfunctioning. If there is 12VDC voltage, the freezer fan can generally be determined to be malfunctioning.
 - 3) If the fan rotates abnormally, the fan is malfunctioning.

Solutions:

- (1) If there is apparent abnormal sound in the freezer storage compartment, check if the fan base is firmly fixed, if the fan vanes are installed properly, and if they intervene with the wires. If any of these problems is found, please remove the fan and reinstall it properly.
- (2) If the fan connector is not installed properly, disconnect the terminals and reinstall the connector.
- (3) If the main control panel or the fan is malfunctioning, replace the malfunctioning one with a good spare part.

TROUBLE SHOOTING

Examination And Solutions For Other Common Problems

Problems	Causes	Solutions
Water/moisture/frost in the refrigerator		
Moisture accumulates on the refrigerators inner walls	<ul style="list-style-type: none"> ● Hot and moist climate. ● The door is not closed tightly ● The door is opened too frequently or for too long time 	<ul style="list-style-type: none"> ● Accumulation of frost and moisture accelerate in such climate. ● Make sure the refrigerator is level and there is no food or container interfering with the door ● Do not open the door so frequently
Water/moisture/frost on outside surface of the refrigerator		
Moisture accumulates on the refrigerator's outside surface or between two doors	<ul style="list-style-type: none"> ● Damp climate ● The refrigerator door is not closed tightly. This causes mixing of the cold air in the refrigerator with the warm air outside it 	<ul style="list-style-type: none"> ● It is normal in damp climate. The moisture will decrease when the humidity drops. ● Make sure the refrigerator is level and there is no food or container interfering with the door
Refrigerator operation		
The compressor does not work	<ul style="list-style-type: none"> ● The refrigerator is in defrosting cycle. ● The refrigerator is not plugged into a power outlet. ● The refrigerator is in OFF state. 	<ul style="list-style-type: none"> ● It is normal for an automatic defrosting refrigerator. ● Verify the plug is plugged in the socket firmly. ● Press the "Power" button for 3 second or more to restart the refrigerator or turn the knob from OFF to temperature selection position.
The fridge storage compartment does not work	<ul style="list-style-type: none"> ● The air door cable is not connected properly. ● The fan does not work ● The fridge storage compartment is turned off 	<ul style="list-style-type: none"> ● Check if the air door cable is not connected properly and install it correctly if not so. Verify that the air door acts normally with the Fridge ON/OFF key on the display panel ● The fan does not work while the refrigeration air door is open. Please check if the door on-off behind the front decoration strip is installed properly. Reinstall it correctly if not so. ● Turn on the fridge storage compartment manually
The refrigerator runs frequently or runs for too long period	<ul style="list-style-type: none"> ● The indoor or outdoor temperature is high ● The refrigerator has been powered off for a period of time. ● The automatic icemaker is operating. ● The door is opened too frequently or for long periods. ● The door of the fridge / freezer storage compartment is not tightly closed. ● The temperature setting for the freezer storage compartment is too low ● The door gasket of the fridge/freezer storage compartment is dirty, worn, cracked or mismatched. ● The condenser is dirty. 	<ul style="list-style-type: none"> ● In this case, it is normal for the refrigerator to run longer. ● Normally, it takes 8 to 12 hours for the refrigerator to totally cool down. ● Icemaking process makes the refrigerator to run longer. ● Warm air enters the refrigerator and causes it to start frequently. Please do not open the door so frequently. ● Make sure the refrigerator is level place and there is no food or container interfering with the door. ● Set the temperature higher until satisfactory refrigerator temperature is obtained. It takes 24 hours for the refrigerator temperature to become stable. ● Clean or replace the door gasket. Leakage gap of door gasket can cause longer running time of the refrigerator in order to maintain desired temperature. ● Clean the condenser.
Too high temperature		

TROUBLE SHOOTING

Too high temperature in the fridge/freezer storage compartment	<ul style="list-style-type: none"> ● The door is opened too frequently or for too long periods of time ● Temperature is set too high ● The door is not closed tightly ● The condenser is dirty 	<ul style="list-style-type: none"> ● Warm air will enter the refrigerator whenever the door is opened. Try to open the door as infrequently as possible. ● Reset the temperature. ● Make sure the refrigerator is on a level surface and there is no food or container interfering with the door. ● Clean the condenser.
The temperature in the freezer storage compartment is too high while the temperature in the fridge storage compartment is OK	<ul style="list-style-type: none"> ● The temperature is set too high 	<ul style="list-style-type: none"> ● Set the freezer temperature lower. It takes 24 hours for the temperature of the refrigerator to become stable.
The temperature in the fridge storage compartment is too high while the temperature in the freezer storage compartment is OK	<ul style="list-style-type: none"> ● The temperature is set too high 	<ul style="list-style-type: none"> ● Set the fridge temperature lower. It takes 24 hours for the temperature of the refrigerator to become stable.
Bad odors in the refrigerator		
The inside of the refrigerator is dirty	<ul style="list-style-type: none"> ● The inside of the refrigerator needs cleaning ● Food with strong odor is stored in the refrigerator 	<ul style="list-style-type: none"> ● Clean the internal of the refrigerator ● Wrap the food tightly.
If you hear...		
Beeps	<ul style="list-style-type: none"> ● The fridge storage compartment door is open ● The temperature in the freezer storage compartment is too high 	<ul style="list-style-type: none"> ● Close the door or silence the alarm manually ● The alarm is normal when it is first started due to relatively higher temperature.
Abnormal sound	<ul style="list-style-type: none"> ● The refrigerator is not located on a level surface ● The refrigerator touches some object around it 	<ul style="list-style-type: none"> ● Adjust the feet to level the refrigerator. ● Remove objects around it.
Slight sound similar to that of flowing water	<ul style="list-style-type: none"> ● It is the sound of the refrigerating system 	<ul style="list-style-type: none"> ● Normal.
Heating of cabinet	<ul style="list-style-type: none"> ● The de-dew tube is de-dewing 	<ul style="list-style-type: none"> ● It is a process to prevent dewing. It is a normal phenomenon.

Sincere Forever



Haier Group

Tel:86-532-88938356

Web site:<http://www.haier.com>